

BEARCAT DAY 22

TUESDAY, APRIL 21, 2020

GRADE 8
ANDERSON COUNTY SCHOOLS



ANDERSON COUNTY MIDDLE SCHOOL

8TH GRADE BEARCAT DAY 22

LANGUAGE ARTS	THE OUTSIDERS (NOVEL STUDY) Read the notes and Chapter 2 of The Outsiders Answer the Google Form Questions Answer the Short Answer
MATH	VOLUME OF SPHERES Students will need to use the notes and examples on the note sheet to help them complete the practice problems on the homework sheet . The homework sheet will need to be returned to the school and turned in for a grade. Students with internet access will need to complete the Google Form for Bearcat Day 22 after using the notes, practice problems, and video lesson to help them prepare
SCIENCE	GEOLOGIC TIME REVIEW Use the time scale & your memory of the last several days to answer the questions on the Geologic Time review .
SOCIAL STUDIES	21-9 ★ the Emancipation Proclamation Questions. 1. What was Abraham Lincoln's objective in fighting the Civil War? 2. From where did the Emancipation Proclamation free slaves? 3. What effect did the Emancipation Proclamation have?
PE/HEALTH	UNDERSTANDING DISEASES Read through the article and notes and complete the two worksheets that follow.
CAREERS	SOFT SKILLS Read the notes about soft skills and answer the questions .

The Outsiders - Chapter 2



By SE Hinton

Grade 8 Bearcat Day 22 ELA

What are two ways Ponyboy is different from Darry and Sodapop?

1

2

//////////

Students, draw anywhere on this slide!



IMAGE # 1

p1 of 2

1. What kind of personality does this person have?
2. What kind of job does or will this person have?
3. If you met this person, would you be friends? Why or why not?

Students, write your response!



IMAGE # 4

Grade 8 Bearcat Day 22 ELA

1. What kind of personality does this person have?
2. What kind of job does or will this person have?
3. If you met this person, would you be friends? Why or why not?

Students, write your response!

p 2 of 2

Consider different viewpoints

Draw or type your thoughts on this topic in one head. Draw or type the point of view of a different person in the other.

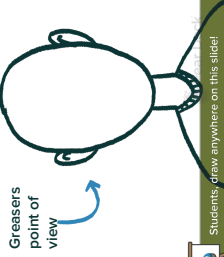

Students, draw anywhere on this slide!

Chapter 1 Review

And you can't win against them no matter how hard you try, because they've got all the breaks and even whipping them isn't going to change that fact."
Chapter 1, pg. 11

Grade 8 Bearcat Day 22 ELA

Draw lines to match the image to the answer:

	HAPPY is to CHEERFUL as CASUAL is to _____
	GENTLE ROUGH :: CALM :: _____
	DECENT GENTLEMAN :: _____ :: SCOUNDREL
	YOUNG GOLD :: _____ :: CRIMINAL
	SENSELESS :: _____ :: FOOLISH
	FRIEND ENEMY :: AGREE :: _____

rough **nonchalant** **scatterbrained**

Free Open-Source Content
© 2013 Pearson Education, Inc.

Students, draw anywhere on this slide!

The Outsiders PDF

[S.E. Hinton: The Outsiders PDF Text \(L1\).pdf](http://S.E. Hinton: The Outsiders PDF Text (L1).pdf)

The Outsiders Audio

Available in CD & DVD formats

Things to do before tomorrow's class:

- 1 Read The Outsiders Chapter 2 (If you read ahead, please do not spoil it for others.)
- 2 Open the Questions Google Form and answer the questions. Remember to check the chapter for correct answers.
- 3 Open the Short Answer Google Form. This assignment is REQUIRED and you must use PACE. You WILL be able to redo this.

Free Open-Source Content
© 2013 Pearson Education, Inc.

Students, write your responses!

P 3 of 21

Grade 8 Bearcat Day 22 ELA

P 4 of 21

Chapter 2

DALLY WAS WAITING for Johnny and me under the street light at the corner of Pickett and Sutton, and since we got there early, we had time to go over the drugstore in the shopping center and goof around. We bought Cokes and blew the straws at the waitress, and walked around eyeing things that were lying out in the open until the manager got wise to us and suggested we leave. He was too late, though; Dally walked out with two packages of Kools under his jacket.

Then we went across the street and down Sutton a little way to The Dingo. There are lots of drive-ins in town--- the Socs go to The Way Out and to Rusty's, and the greasers go to The Dingo and to Jay's. The Dingo is a pretty rough hangout; there's always a fight going on there and once a girl got shot. We walked around talking to all the greasers and hoods we knew, leaning in car windows or hopping into the back seats, and getting in on who was running away, and who was in jail, and who was going with who, and who could whip who, and who stole what and when and why. We knew about everybody there. There was a pretty good fight while we were there between a big twenty-three-year-old greaser and a Mexican hitchhiker. We left when the switchblades came out, because the cops would be coming soon and nobody in his right mind wants to be around when the fuzz show.

We crossed Sutton and cut around behind Spencer's Special, the discount house, and chased two junior-high kids across a field for a few minutes; by then it was dark enough to sneak in over the back fence of the Nightly Double drive-in movie. It was the biggest in town, and showed two movies every night, and on weekends four--- you could say you were going to the Nightly Double and have time to go all over town.

We all had the money to get in--- it only costs a quarter if you're not in a car--- but Dally hated to do things the legal way. He liked to show that he didn't care whether there was a law or not. He went around trying to break laws. We went to the rows of seats in front of the concession stand to sit down. Nobody else was there except two girls who were sitting down front. Dally eyed them coolly, then walked down the aisle and sat right

behind them. I had a sick feeling that Dally was up to his usual tricks, and I was right. He started talking, loud enough for the two girls to hear. He started out bad and got worse. Dallas could talk awful dirty if he wanted to and I guess he wanted to then. I felt my ears get hot. Two-Bit or Steve or even Soda would have gone right along with him, just to see if they could embarrass the girls, but that kind of kicks just doesn't appeal to me. I sat there, struck dumb, and Johnny left hastily to get a Coke.

I wouldn't have felt so embarrassed if they had been greasy girls--- I might even have helped old Dallas. But those two girls weren't our kind. They were tuff-looking girls--- dressed sharp and really good-looking. They looked about sixteen or seventeen. One had short dark hair, and the other had long red hair. The redhead was getting mad, or scared. She sat up straight and she was chewing hard on her gum. The other one pretended not to hear Dally. Dally was getting impatient. He put his feet up on the back of the redhead's chair, winked at me, and beat his own record for saying something dirty. She turned around and gave him a cool stare.

"Take your feet off my chair and shut your trap."

Boy, she was good-looking. I'd seen her before; she was a cheerleader at our school. I'd always thought she was stuck-up.

Dally merely looked at her and kept his feet where they were. "Who's gonna make me?"

The other one fumed around and watched us. "That's the greaser that jockeys for the Slash J sometime," she said, as if we couldn't hear her.

I had heard the same tone a million times: "Greaser... greaser... greaser." Oh yeah, I had heard that tone before too many times. What are they doing at a drive-in without a car? I thought, and Dallas said, "I know you two. I've seen you around rodeos."

"It's a shame you can't ride bull half as good as you can talk it," the redhead said coolly and turned back around.

That didn't bother Dally in the least. "You two barrel race, huh?"

"You'd better leave us alone," the redhead said in a biting voice, "or I'll call the cops."

"Oh, my, my"--- Dally looked bored--- "you've got me scared to death. You ought to see my record sometime, baby." He grinned slyly. "Guess what I've been in for?"

"Please leave us alone," she said. "Why don't you be nice and leave us alone?"

Dally grinned roguishly. "I'm never nice. Want a Coke?"

She was mad by then. "I wouldn't drink it if I was starving in the desert. Get lost, hood!"

Dally merely shrugged and strolled off.

The girl looked at me. I was half-scared of her. I'm half-scared of all nice girls, especially Socs. "Are you going to start in on us?"

I shook my head, wide-eyed. "No."

Suddenly she smiled. Gosh, she was pretty. "You don't look the type. What's your name?"

I wished she hadn't asked me that. I hate to tell people my name for the first time. "Ponyboy Curtis."

Then I waited for the "You're kidding!" or "That's your real name?" or one of the other remarks I usually get. Ponyboy's my real name and personally I like it.

The redhead just smiled. "That's an original and lovely name."

"My dad was an original person," I said. "I've got a brother named Sodapop, and it says so on his birth certificate."

"My name's Sherri, but I'm called Cherry because of my hair. Cherry Valance."

"I know," I said. "You're a cheerleader. We go to the same school."

"You don't look old enough to be going to high school," the dark-haired girl said.

"I'm not. I got put up a year in grade school."

Cherry was looking at me. "What's a nice, smart kid like you running around with trash like that for?"

I felt myself stiffen. "I'm a grease, same as Dally. He's my buddy."

"I'm sorry, Ponyboy," she said softly. Then she said briskly, "Your brother Sodapop, does he work at a gasoline station? A DX, I think?"

"Yeah."

"Man, your brother is one doll. I might have guessed you were brothers--- you look alike."

I grinned with pride--- I don't think I look one bit like Soda, but it's not every day I hear Socs telling me they think my brother is a doll.

"Didn't he used to ride in rodeos? Saddle bronc?"

"Yeah. Dad made him quit after he tore a ligament, though. We still hang around rodeos a lot. I've seen you two barrel race. You're good."

"Thanks," Cherry said, and the other girl, who was named Marcia, said, "How come we don't see your brother at school? He's not any older than sixteen or seventeen, is he?"

I winced inside. I've told you I can't stand it that Soda dropped out. "He's a dropout," I said roughly. "Dropout" made me think of some poor dumb-looking hoodlum

wandering the streets breaking out street lights--- it didn't fit my happy-go-lucky brother at all. It fitted Dally perfectly, but you could hardly say it about Soda.

Johnny came back then and sat down beside me. He looked around for Dally, then managed a shy "Hi" to the girls and tried to watch the movie. He was nervous, though. Johnny was always nervous around strangers. Cherry looked at him, sizing him up as she had me. Then she smiled softly, and I knew she had him sized up right.

Dally came striding back with an armful of Cokes. He handed one to each of the girls and sat down beside Cherry. "This might cool you off."

She gave him an incredulous look; and then she threw her Coke in his face. "That might cool you off, greaser. After you wash your mouth and learn to talk and act decent, I might cool off, too."

Dally wiped the Coke off his face with his sleeve and smiled dangerously. If I had been Cherry I would have beat it out of there. I knew that smile.

"Fiery, huh? Well, that's the way I like 'em." He started to put his arm around her, but Johnny reached over and stopped him.

"Leave her alone, Dally."

"Huh?" Dally was taken off guard. He stared at Johnny in disbelief. Johnny couldn't say "Boo" to a goose. Johnny gulped and got a little pale, but he said, "You heard me. Leave her alone."

Dallas scowled for a second. If it had been me, or Two-Bit, or Soda or Steve, or anyone but Johnny, Dally would have flattened him without a moment's hesitation. You just didn't tell Dally Winston what to do. One time, in a dime store, a guy told him to move over at the candy counter. Dally had turned around and belted him so hard it knocked a tooth loose. A complete stranger, too. But Johnny was the gang's pet, and Dally just couldn't hit him. He was Dally's pet, too. Dally got up and stalked off, his fists jammed in his pockets and a frown on his face. He didn't come back.

Cherry sighed in relief. "Thanks. He had me scared to death."

p9of21

Johnny managed an admiring grin. "You sure didn't show it. Nobody talks to Dally like that."

She smiled, "From what I saw, you do."

Johnny's ears got red. I was still staring at him. It had taken more than nerve for him to say what he'd said to Dally--- Johnny worshiped the ground Dallas walked on, and I had never heard Johnny talk back to anyone, much less his hero.

Marcia grinned at us. She was a little smaller than Cherry. She was cute, but that Cherry Valance was a real looker. "Y'all sit up here with us. You can protect us."

Johnny and I looked at each other. He grinned suddenly, raising his eyebrows so that they disappeared under his bangs. Would we ever have something to tell the boys! his eyes said plainly. We had picked up two girls, and classy ones at that. Not any greasy broads for us, but real Socs. Soda would flip when I told him.

"Okay," I said nonchalantly, "might as well."

I sat between them, and Johnny sat next to Cherry.

"How old are y'all?" Marcia asked.

"Fourteen," I said.

"Sixteen," said Johnny.

"That's funny," Marcia said, "I thought you were both..."

"Sixteen," Cherry finished for her.

I was grateful. Johnny looked fourteen and he knew it and it bugged him something awful.

p10of21

Johnny grinned. "How come y'all ain't scared of us like you were Dally?"

Cherry sighed. "You two are too sweet to scare anyone. First of all, you didn't join in Dallas's dirty talk, and you made him leave us alone. Aid when we asked you to sit up here with us, you didn't act like it was an invitation to make out for the night. Besides that, I've heard about Dallas Winston, and he looked as hard as nails and twice as tough. And you two don't look mean."

"Sure," I said tiredly, "we're young and innocent"

"No," Cherry said slowly, looking at me carefully, "not innocent. You've seen too much to be innocent. Just not... dirty."

"Dally's okay," Johnny said defensively, and I nodded. You take up for your buddies, no matter what they do. When you're a gang, you stick up for the members. If you don't stickup for them, stick together, make like brothers, it isn't a gang any more. It's a pack. A snarling, distrustful, bickering pack like the Socs in their social clubs or the street gangs in New York or the wolves in the timber. "He's tough, but he's a cool old guy."

"He'd leave you alone if he knew you," I said, and that was true. When Steve's cousin from Kansas came down, Dally was decent to her and watched his swearing. We all did around nice girls who were the cousinly type. I don't know how to explain it--- we try to be nice to the girls we see once in awhile, like cousins or the girls in class; but we still watch a nice girl go by on a street corner and say all kinds of lousy stuff about her. Don't ask me why. I don't know why.

"Well," Marcia said with finality, "I'm glad he doesn't know us."

"I kind of admire him," Cherry said softly, so only I heard, and then we settled down to watch the movie.

Oh, yeah, we found out why they were without a car. They'd come with their boyfriends, but walked out on them when they found out the boys had brought some booze along. The boys had gotten angry and left.

"I don't care if they did." Cherry sounded annoyed. "It's not my idea of a good time to sit in a drive-in and watch people get drunk."

You could tell by the way she said it that her idea of a good time was probably, high-class, and probably expensive. They'd decided to stay and see the movie anyway. It was one of those beach-party movies with no plot and no acting but a lot of girls in bikinis and some swinging songs, so it was all right. We were all four sitting there in silence when suddenly a strong hand came down on Johnny's shoulder and another on mine and a deep voice said, "Okay, greasers, you've had it"

I almost jumped out of my skin. It was like having someone leap out from behind a door and yell "Boo!" at you.

I looked fearfully over my shoulder and there was Two-Bit, grinning like a Chessy cat. "Glory, Two-Bit, scare us to death!" He was good at voice imitations and had sounded for all the world like a snarling Soc. Then I looked at Johnny. His eyes were shut and he was as white as a ghost. His breath was coming in smothered gasps. Two-Bit knew better than to scare Johnny like that. I guess he'd forgotten. He's kind of scatterbrained. Johnny opened his eyes and said weakly, "Hey, Two-Bit."

Two-Bit messed up his hair, "Sorry, kid," he said, "I forgot."

He climbed over the chair and plopped down beside Marcia. "Who's this, your great-aunts?"

"Great-grandmothers, twice removed," Cherry said smoothly.

I couldn't tell if Two-Bit was drunk or not. It's kind of hard to tell with him--- he acts boozed up sometimes even when he's sober. He cocked one eyebrow up and the

other down, which he always does when something puzzles him, or bothers him, or when he feels like saying something smart. "Shoot, you're ninety-six if you're a day."

"I'm a night," Marcia said brightly.

Two-Bit stared at her admiringly. "Brother, you're a sharp one. Where'd you two ever get to be picked up by a couple of greasy hoods like Pony and Johnny?"

"We really picked them up," Marcia said. "We're really Arabian slave traders and we're thinking about shanghaiing them. They're worth ten camels apiece at least."

"Five," Two-Bit disagreed. "They don't talk Arabian, I don't think. Say somethin' in Arabian, Johnnycake."

"Aw, cut it out!" Johnny broke in. "Dally was bothering them and when he left they wanted us to sit with them to protect them. Against wisecracking greasers like you, probably."

Two-Bit grinned, because Johnny didn't usually get sassy like that. We thought we were doing good if we could get him to talk at all. Incidentally, we don't mind being called greaser by another greaser. It's kind of playful then.

"Hey, where is of Dally, anyways?"

"He went hunting some action--- booze or dames or a fight. I hope he don't get jailed again. He just got out"

"He'll probably find the fight," Two-Bit stated cheerfully. "That's why I came over. Mr. Timothy Shepard and Co. are looking for whoever so kindly slashed their car's tires, and since Mr. Curly Shepard spotted Dallas doing it... well... Does Dally have a blade?"

"Not that I know of," I said. "I think he's got a piece of pipe, but he busted his blade this morning."

"Good. Tim'll fight fair if Dally don't pull a blade on him. Dally shouldn't have any trouble."

Cherry and Marcia were staring at us. "You don't believe in playing rough or anything, do you?"

"A fair fight isn't rough," Two-Bit said. "Blades are rough. So are chains and heaters and pool sticks and rumbles. Skin fighting isn't rough. It blows off steam better than anything. There's nothing wrong with throwing a few punches. Socs are rough. They gang up on one or two, or they rumble each other with their social clubs. Us greasers usually stick together, but when we do fight among ourselves, it's a fair fight between two. And Dally deserves whatever he gets, 'cause slashed tires ain't no joke when you've got to work to pay for them. He got spotted, too, and that was his fault. Our one rule, besides Stick together, is Don't get caught. He might get beat up, he might not. Either way there's not going to be any blood feud between our outfit and Shepard's, if we needed them tomorrow they'd show. If Tim beats Dally's head in, and then tomorrow asks us for help in a rumble, we'll show. Dally was getting kicks. He got caught. He pays up. No sweat."

"Yeah, boy," Cherry said sarcastically, "real simple."

"Sure," Marcia said, unconcerned. "If he gets killed or something, you just bury him. No sweat"

"You dig okay, baby." Two-Bit grinned and lit a cigarette. "Anyone want a weed?"

I looked at Two-Bit admiringly. He sure put things into words good. Maybe he was still a junior at eighteen and a half, and maybe his sideburns were too long, and maybe he did get boozed up too much, but he sure understood things.

Cherry and Marcia shook their heads at his offering of cigarettes, but Johnny and I reached for one. Johnny's color was back and his breathing was regular, but his hand was shaking ever so slightly. A cigarette would steady it.

"Ponyboy, will you come with me to get some popcorn?" Cherry asked.

I jumped up. "Sure. Y'all want some?"

"I do," said Marcia. She was finishing the Coke Dally had given her. I realized then that Marcia and Cherry weren't alike. Cherry had said she wouldn't drink Dally's Coke if she was starving, and she meant it. It was the principle of the thing. But Marcia saw no reason to throw away a perfectly good, free Coke.

"Me too," said Two-Bit. He flipped me a fifty cent piece. "Get Johnny some, too. I'm buyin'," he added as Johnny started to reach into his jeans pocket.

We went to the concession stand and, as usual, there was a line a mile long, so we had to wait. Quite a few kids turned to look at us--- you didn't see a kid grease and a Socy cheerleader together often. Cherry didn't seem to notice.

"Your friend--- the one with the sideburns--- he's okay?"

"He ain't dangerous like Dallas if that's what you mean. He's okay."

She smiled and her eyes showed that her mind was on something else. "Johnny... he's been hurt bad sometime, hasn't he?" It was more of a statement than a question. "Hurt and scared."

"It was the Socs," I said nervously, because there were plenty of Socs milling around and some of them were giving me funny looks, as if I shouldn't be with Cherry or something. And I don't like to talk about it either--- Johnny getting beat up, I mean. But I started in, talking a little faster than I usually do because I don't like to think about it either.

IT WAS ALMOST four months ago. I had walked down to the DX station to get a bottle of pop and to see Steve and Soda, because they'll always buy me a couple of bottles and let me help work on the cars. I don't like to go on weekends because then there is usually a bunch of girls down there flirting with Soda--- all kinds of girls, Socs too. I don't care too much for girls yet. Soda says I'll grow out of it. He did.

It was a warmish spring day with the sun shining bright, but it was getting chilly and dark by the time we started for home. We were walking because we had left Steve's car at the station. At the corner of our block there's a wide, open field where we play football and hang out, and it's often a site for rumbles and fist fights. We were passing it, kicking rocks down the street and finishing our last bottle of Pepsi, when Steve noticed something lying on the ground. He picked it up. It was Johnny's blue-jeans jacket--- the only jacket he had.

"Looks like Johnny forgot his jacket," Steve said, slinging it over his shoulder to take it by Johnny's house. Suddenly he stopped and examined it more carefully. There was a stain the color of rust across the collar. He looked at the ground. There were some more stains on the grass. He looked up and across the field with a stricken expression on his face. I think we all heard the low moan and saw the dark motionless hump on the other side of the lot at the same time. Soda reached him first. Johnny was lying face down on the ground. Soda turned him over gently, and I nearly got sick. Someone had beaten him badly.

We were used to seeing Johnny banged up--- his father clobbered him around a lot, and although it made us madder than heck, we couldn't do anything about it. But those beatings had been nothing like this. Johnny's face was cut up and bruised and swollen, and there was a wide gash from his temple to his cheekbone. He would carry that scar all his life. His white T-shirt was splattered with blood. I just stood there, trembling with sudden cold. I thought he might be dead; surely nobody could be beaten like that and live. Steve closed his eyes for a second and muffled a groan as he dropped on his knees beside Soda.

Somehow the gang sensed what had happened. Two-Bit was suddenly there beside me, and for once his comical grin was gone and his dancing gray eyes were stormy. Darry had seen us from our porch and ran toward us, suddenly skidding to a halt. Dally was there, too, swearing under his breath, and turning away with a sick expression on his face. I wondered about it vaguely. Dally had seen people killed on the streets of New York's West Side. Why did he look sick now?

"Johnny?" Soda lifted him up and held him against his shoulder. He gave the limp body a slight shake. "Hey, Johnnycake."

Johnny didn't open his eyes, but there came a soft question. "Soda?"

"Yeah, it's me," Sodapop said. "Don't talk. You're gonna be okay."

"There was a whole bunch of them," Johnny went on, swallowing, ignoring Soda's command. "A blue Mustang full... I got so scared..." He tried to swear, but suddenly started crying, fighting to control himself, then sobbing all the more because he couldn't. I had seen Johnny take a whipping with a two-by-four from his old man and never let out a whimper. That made it worse to see him break now. Soda just held him and pushed Johnny's hair back out of his eyes. "It's okay, Johnnycake, they're gone now. It's okay."

Finally, between sobs, Johnny managed to gasp out his story. He had been hunting our football to practice a few kicks when a blue Mustang had pulled up beside the lot. There were four Socs in it. They had caught him and one of them had a lot of rings on his hand--- that's what had cut Johnny up so badly. It wasn't just that they had beaten him half to death--- he could take that. They had scared him. They had threatened him with everything under the sun. Johnny was high-strung anyway, a nervous wreck from getting belted every time he turned around and from hearing his parents fight all the time. Living in those conditions might have turned someone else rebellious and bitter; it was killing Johnny. He had never been a coward. He was a good man in a rumble. He stuck up for the gang and kept his mouth shut good around cops. But after the night of the beating, Johnny was jumpier than ever. I didn't think he'd ever get over it. Johnny never

walked by himself after that. And Johnny, who was the most law-abiding of us, now carried in his back pocket a six-inch switchblade. He'd use it, too, if he ever got jumped again. They had scared him that much. He would kill the next person who jumped him. Nobody was ever going to beat him like that again. Not over his dead body...

I HAD NEARLY forgotten that Cherry was listening to me. But when I came back to reality and looked at her, I was startled to find her as white as a sheet.

"All Socs aren't like that," she said. "You have to believe me, Ponyboy. Not all of us are like that."

"Sure," I said.

"That's like saying all you greasers are like Dallas Winston. I'll bet he's jumped a few people."

I digested that. It was true. Dally had jumped people. He had told us stories about muggings in New York that made the hair on the back of my neck stand up. But not all of us were that bad.

Cherry no longer looked sick, only sad. "I'll bet you think the Socs have it made. The rich kids, the West-side Socs. I'll tell you something, Ponyboy, and it may come as a surprise. We have troubles you've never even heard of. You want to know something?" She looked me straight in the eye. "Things are rough all over."

"I believe you," I said. "We'd better get back out there with the popcorn or Two-Bit'll think I ran off with his money."

We went back and watched the movie through again. Marcia and Two-Bit were hitting it off fine. Both had the same scatterbrained sense of humor. But Cherry and Johnny and I just sat there, looking at the movie and not talking. I quit worrying about everything and thought about how nice it was to sit with a girl without having to listen to her swear or to beat her off with a club. I knew Johnny liked it, too. He didn't talk to girls much. Once, while Dallas was in reform school, Sylvia had started hanging on to Johnny

and sweet talking him and Steve got hold of her and told her if she tried any of her tricks with Johnny he'd personally beat the tar out of her. Then he gave Johnny a lecture on girls and how a sneaking little broad like Sylvia would get him into a lot of trouble. As a result, Johnny never spoke to girls much, but whether that was because he was scared of Steve or because he was shy, I couldn't tell.

I got the same lecture from Two-Bit after we'd picked up a couple of girls downtown one day. I thought it was funny, because girls are one subject even Darry thinks I use my head about. And it really had been funny, because Two-Bit was half crooked when he gave me the lecture, and he told me some stories that about made me want to crawl under the floor or something. But he had been talking about girls like Sylvia and the girls he and Dally and the rest picked up at drive-ins and downtown; he never said anything about Socy girls. So I figured it was all right to be sitting there with them. Even if they did have their own troubles. I really couldn't see what Socs would have to sweat about--- good grades, good cars, good girls, madras and Mustangs and Corvairs--- Man, I thought, if I had worries like that I'd consider myself lucky.

I know better now.

p 19 of 21

22. Bearcat Day 22 4/21/2020 The Outsiders - Chapter 2 Quiz

* Required

Part 1: Matching

Choose: Write the letter beside the correct Character.

Cherry *

Choose

- A. doesn't believe the Socs have problems of their own
- B. A tough guy from New York who likes to break the law
- C. scares Johnny at the movie theater
- D. throws a Coke in Dally's face
- E. Brutally beaten up by the Socs

Johnny *

Choose

Dally *

2 points

Choose

Two-Bit *

p 20 of 21

2 points

Choose

Ponyboy *

2 points

Choose

Back

Next

Never submit passwords through Google Forms.

This content is neither created nor endorsed by Google. [Report Abuse](#) - [Terms of Service](#) - [Privacy Policy](#).

Google Forms

22. Bearcat Day 22 4/21/2020 Short Answer

P21 of 21

* Required

Using RACE-A flashback is a device that an author uses to interrupt a story in order to relate an event that happened at an earlier time. Why did the author use a flashback and why was the information important? (Remember to tell what the flashback is and use textual evidence.) * 25 points

Your answer

Name and Class Period (Capitalize where appropriate)

Your answer

Submit

Never submit passwords through Google Forms.

This form was created inside of Anderson County Schools. [Report Abuse](#)

Google Forms

Grade 8 Bearcat Day 22 Math

Unit: Volume
Student Handout 4

Name _____ Answer Key _____
Date _____ Pd _____

VOLUME OF SPHERES

VOLUME OF SPHERES

- The volume of a sphere can be found by using the formula $\frac{4}{3}\pi r^3$.
- Half of a sphere is called a hemisphere.

If a cylinder and a sphere have the same radius and the same height (the height of the sphere would be $2r$), then the sphere will have $\frac{2}{3}$ the volume of the cylinder. Use this fact to help you see how the formula for the volume of spheres was derived in the table below.

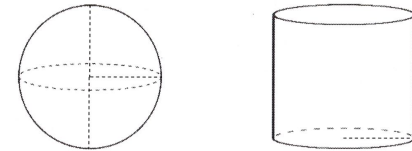

1. Formula for volume of a cylinder	$\pi r^2 h$
2. Replace "h" with "2r"	$\pi r^2 (2r)$
3. Multiply the formula by $\frac{2}{3}$	$\frac{2}{3} \pi r^2 (2r)$
4. Simplify	$\frac{4}{3} \pi r^3$

Find the volume of each sphere and use 3.14 for π .

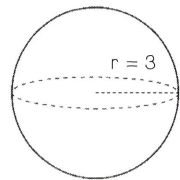
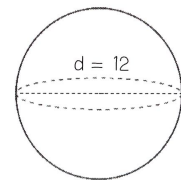
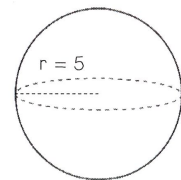
1. 	2. 	3. 
Formula: $\frac{4}{3}\pi r^3$	Formula: $\frac{4}{3}\pi r^3$	Formula: $\frac{4}{3}\pi r^3$
Plug in values: $\frac{4}{3}(3.14)(3^3)$	Plug in values: $\frac{4}{3}(3.14)(6^3)$	Plug in values: $\frac{4}{3}(3.14)(5^3)$
Volume: 113.04 units ³	Volume: 904.32 units ³	Volume: 523.3 units ³

Grade 8 Bearcat Day 22 Math

Unit: Volume
Homework 3

Name _____
Date _____ Pd _____

VOLUME OF SPHERES

Part I: Draw a line connecting each sphere to its volume in terms of π and rounded to the nearest tenth. (Not all of the values will be used.)

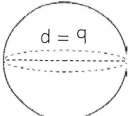
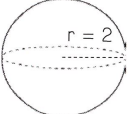
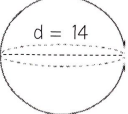
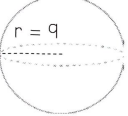
SPHERE	VOLUME (IN TERMS OF π)	VOLUME (NEAREST TENTH)
1. 	$457.\bar{3}\pi$ units ³	3,052.1 units ³
2. 	121.5π units ³	67 units ³
3. 	$21.\bar{3}\pi$ units ³	33.5 units ³
4. 	$10.\bar{6}\pi$ units ³	381.5 units ³
	972π units ³	10,052.2 units ³
	$3,201.\bar{3}\pi$ units ³	1,436 units ³

Part II: Answer each question below.

5. Find the volume of a hemisphere that has a radius of 8 centimeters. Round to the nearest tenth. _____	6. Find the volume of a hemisphere that has a diameter of 48 inches. Leave your answer in terms of π . _____
7. A sphere has a volume of 36π in ³ . Find the radius of the sphere. _____	8. A sphere has a volume of $2,304\pi$ mm ³ . Find the diameter of the sphere. _____

Grade 8 Bearcat Day 22 Science







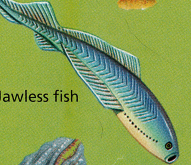



Figure 22 Geologic History

Precambrian Time

4.6 billion–544 million years ago

Paleozoic Era

544–245 million years ago

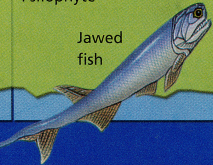
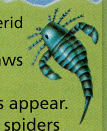
Period	Cambrian	Ordovician	Silurian
	544–505 million years ago	505–438 million years ago	438–408 million years ago
Geologic Events	<ul style="list-style-type: none"> Earth forms about 4.6 billion years ago. Oceans form and cover Earth about 4 billion years ago. First sedimentary rocks form about 4 billion years ago. 	<ul style="list-style-type: none"> Shallow seas cover much of the land. Ancient continents lie near or south of the equator. 	<ul style="list-style-type: none"> Warm, shallow seas cover much of Earth. Ice cap covers what is now North Africa.
Development of Life	<ul style="list-style-type: none"> Bacteria appear about 3.5 billion years ago. Soft-bodied, multicellular organisms develop late in the Precambrian. First mass extinction probably occurs near the end of the Precambrian. 	<ul style="list-style-type: none"> Great "explosion" of invertebrate life occurs in seas. Invertebrates with shells appear, including trilobites and mollusks. 	<ul style="list-style-type: none"> Invertebrates dominate the oceans. Early vertebrates—jawless fish—become common.
	 Sea pen  Early bacteria  Jellyfish-like animal  Trilobite  Sponges  Brachiopod  Pikaia  Jawless fish  Crinoid  Arachnid  Psilophyte  Jawed fish  Eurypterid		

Paleozoic Era

544–245 million years ago

















Devonian 408–360 million years ago	Carboniferous 360–286 million years ago Mississippian 360–320 million years ago	Pennsylvanian 320–286 million years ago	Permian 286–245 million years ago
<p>Geologic Events</p> <ul style="list-style-type: none"> Seas rise and fall over what is now North America. Appalachian Mountains begin to form. North America and Northern Europe lie in warm, tropical region. Deserts become larger in tropical regions. The supercontinent Pangaea forms as all continents join together. 			
<p>Development of Life</p> <ul style="list-style-type: none"> Age of Fishes begins as sharks and fish with scales and bony skeletons become common. Trilobites and corals flourish in the oceans. Lungfish develop. First amphibians reach land. Great swamp forests of huge, woody trees cover eastern North America and parts of Europe. First true reptiles appear. Winged insects appear. Reptiles become dominant on land. Warm-blooded reptiles appear. Mass extinction of many marine invertebrates, including trilobites. 			
 Shark  Bony fish  Devonian forest	 Cockroach  Amphibian  Coal forest	 Dragonfly  Conifer  Dimetrodon  Dicynodon	

Figure 22 Geologic History

Mesozoic Era

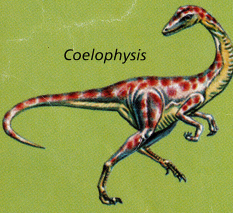
245–66 million years ago

Triassic 245–208 million years ago	Jurassic 208–144 million years ago
<p>Geologic Events</p> <ul style="list-style-type: none"> Pangaea holds together for much of the Triassic. Hot, dry conditions dominate the center of Pangaea. Pangaea breaks apart as North America separates from Africa and South America. 	
<p>Development of Life</p> <ul style="list-style-type: none"> Age of Reptiles begins. First dinosaurs appear. First mammals, which evolve from warm-blooded reptiles, appear. First turtles and crocodiles appear. Conifers, palmlike trees, and ginkgo trees dominate forests. Largest dinosaurs thrive, including <i>Stegosaurus</i>, <i>Diplodocus</i>, and <i>Apatosaurus</i>. First birds appear. First flying reptiles, pterosaurs, appear. 	
 Megazostrodon  Coelophysis  Cycad	 Archaeopteryx  Morganucodon  Diplodocus

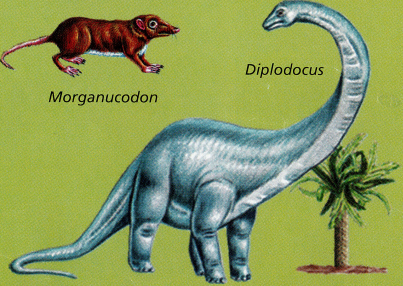
Grade 8 Bearcat Day 22 Science

Mesozoic Era

245–66 million years ago

Cretaceous

144–66 million years ago

Geologic Events

- Continents move toward their present-day positions, as South America splits from Africa.
- Widespread volcanic activity occurs.

Development of Life

- First flowering plants appear.
- Dinosaurs, including *Tyrannosaurus rex*, dominate.
- First snakes appear.
- Mass extinction at end of period causes disappearance of many land and marine life forms, including dinosaurs.

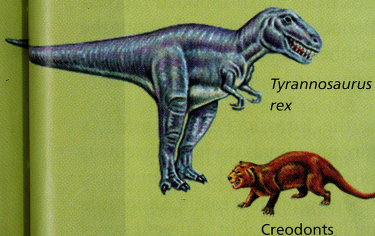

Cenozoic Era

66 million years ago to present

Tertiary

66–1.8 million years ago

- The Rocky Mountains and Himalayas form.
- Continents continue to move into present-day positions.
- Continental glacier covers Antarctica.



- Flowering plants thrive.
- First grasses appear.
- Age of Mammals begins.
- Modern groups such as horses, elephants, bears, rodents, and primates appear.
- Ancestors of humans evolve.

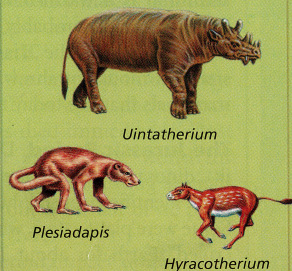

Quaternary

1.8 million years ago to the present

- Thick glaciers advance and retreat over much of North America and Europe, parts of South America and Asia, and all of Antarctica.



- Mammals, flowering plants, and insects dominate land.
- Modern humans evolve in Africa about 100,000 years ago.
- Giant mammals of North America and Eurasia become extinct when the Ice Age ends about 10,000 years ago.

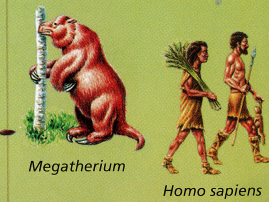

Grade 8 Bearcat Day 22 Science

Bearcat Day 22: Geologic Time Scale Review

Name _____ Pd. _____

Use your chart of the Geologic Time Scale to answer the following questions. Write the correct geologic time for the items below.

Pre-Cambrian Paleozoic Mesozoic Cenozoic

- _____ 1. An era of geologic time that includes from 65 million years ago to today
- _____ 2. An era of geologic time that is younger than Paleozoic Era, but older than Cenozoic
- _____ 3. Time that comprises 85% of Earth's geologic history (Longest - lasted 4 billion years)
- _____ 4. Era when one would have seen dinosaurs roaming the Earth
- _____ 5. An era of geologic time that means "Age of the Mammals"
- _____ 6. An era known as the "Age of Reptiles"
- _____ 7. An era known as the "Age of Fish"
- _____ 8. Era when coal was forming in Kentucky (think coal forests)
- _____ 9. Era with widespread warm and shallow seas
- _____ 10. Era that the Earth is currently experiencing
- _____ 11. Fish were found in every era but _____
- _____ 12. Era that had the earliest evidence of life
- _____ 13. Era that lasted 300 million years
- _____ 14. Era that one would have seen giant mammals like mammoths
- _____ 15. This era had the first land plants – mosses, ferns

Two last questions!!!

1. Would it be possible to find the fossil of a fish dating back to 400 million years ago? Why or why not?

(Write sentence)

2. Why might scientists be amazed if you found a bird fossil that dated back to the Paleozoic Era?

(Write sentence)

Grade 8 Bearcat Day 22 social studies

21-9 ★ THE EMANCIPATION PROCLAMATION, 1863

“My paramount object in this struggle is to save the union, and is not either to save or to destroy slavery. If I could save the Union without freeing any slave I would do it, and if I could save it by freeing all the slaves I would do it; and if I could save it by freeing some and leaving others alone I would also do that.... I intend no modification of my oft-expressed personal wish that all men everywhere could be free.”—Abraham Lincoln, 1862

President Lincoln and Congress agreed on the purpose of the war.

It was to restore the Union—not free the slaves. But pressure built to make the war a crusade against slavery. In 1863 Lincoln used his authority as commander in chief to strike a blow at the Confederates. He freed their slaves by the EMANCIPATION PROCLAMATION.

The Emancipation Proclamation freed only the slaves in Confederate states that were still in rebellion against the Union. It did not free slaves in the border states loyal to the Union.

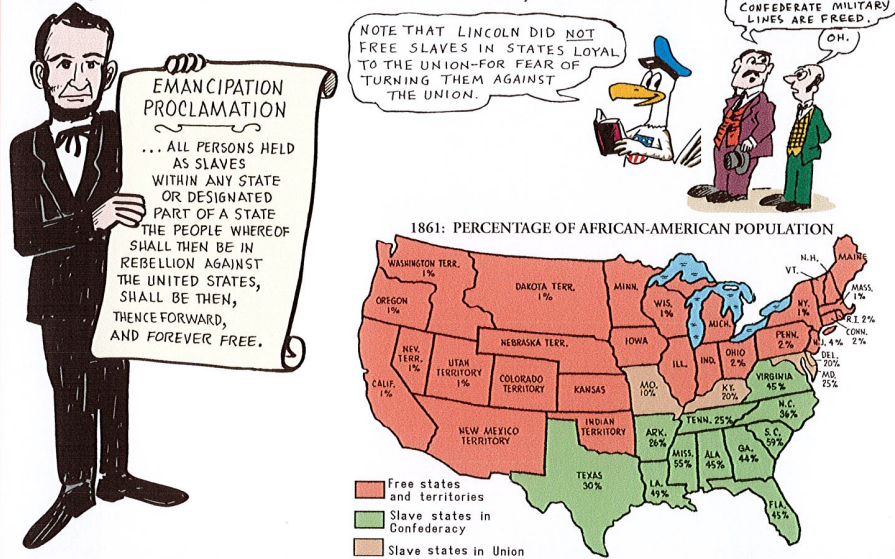

IMPACT OF THE EMANCIPATION PROCLAMATION

The Proclamation turned the war into a fight for freedom as well as for union.



It swayed British opinion to the Union side.



It persuaded blacks to enlist in the Union army.



Grade 8 Bearcat Day 22 Health

Understanding Diseases: Notes

Causes and Spread of Disease

- Pathogen: germ or disease causing agent; single celled or multicelled. Includes: viruses, bacteria, protozoa, fungi, and rickettsia
- Communicable disease: illness caused by pathogens; passed to a person from another person, animal or object

Pathogens and Associated Diseases

Pathogen	Description	Diseases
Bacteria	Single-celled microorganisms that live everywhere; when they enter the body, they rapidly reproduce	Strep throat, Lyme disease, urinary tract infections
Viruses	Smallest and simplest; they are not living organisms, but can reproduce inside living cells	Colds, chicken pox, small-pox, measles, herpes
Protozoa	Single-celled organisms that may capture other life forms for food; some can live inside the body as parasites.	Malaria, Dysentery
Fungi	Single-celled or multicelled organisms that feed on organic material.	Athlete's foot, ringworm, nail fungal infections
Rickettsia	Pathogens similar to bacteria, but multiply like viruses.	Typhus, Rocky Mountain spotted fever

The Immune System:

First Line of Defense

- Skin, mucous membranes, tears, saliva, sweat, and stomach acid
- Membranes of the nose and windpipe are lined with tiny hairlike structures that trap dust and other particles and expel them.
- Tears, saliva and sweat contain chemicals that destroy pathogens
- Stomach acid attacks and destroys pathogens that survive in the mouth and throat.

The Immune System:

Second Line of Defense

- Nonspecific immune response
- Phagocytes: white blood cells that find, engulf, and digest pathogens- scavenger cells
- Release chemicals that cause an inflammatory response, which destroys pathogens
- If infection spreads, body temperature is raised (causing fever); fever kills pathogens.

The Immune System

Third Line of Defense

- Specific immune response: reaction that targets particular invading pathogens
- Lymph: clear liquid found throughout body tissue, eliminates foreign organisms by passing them through lymph nodes
- Lymph Nodes: small filter-like structures located throughout the body
- Lymphocyte: white blood cell serves as building block of immune system; produced by bone marrow
- Antigens: substances that cause immune response; attached to invading pathogens
- Antibody: protein in the blood that destroys a specific antigen

Immunity:

the body's ability to resist disease

- Naturally Acquired Active immunity: body comes in contact with antigen and develops disease; body builds a defense against antigen
- Artificially Acquired Active immunity: occurs after receiving a vaccine
- Naturally Acquired Passive immunity: mother passes antibodies to fetus
- Artificially Acquired Passive immunity: occurs after injection of antibody

Name _____

Date _____



The Perils of Pathogens

Write a definition for each kind of pathogen on the lines below it. Then look at the list of diseases below. In the box in front of each disease, write the letter of the pathogen responsible for it.

A. Viruses

B. Bacteria

C. Rickettsia

D. Fungi

E. Protozoa

- | | | | |
|--------------------------|------------------------------|--------------------------|----------------------------------|
| <input type="checkbox"/> | 1. Athlete's foot | <input type="checkbox"/> | 9. Herpes |
| <input type="checkbox"/> | 2. Malaria | <input type="checkbox"/> | 10. Candidiasis |
| <input type="checkbox"/> | 3. Gonorrhea | <input type="checkbox"/> | 11. Dysentery |
| <input type="checkbox"/> | 4. Influenza | <input type="checkbox"/> | 12. Syphilis |
| <input type="checkbox"/> | 5. Tuberculosis | <input type="checkbox"/> | 13. Chickenpox |
| <input type="checkbox"/> | 6. Nail infections | <input type="checkbox"/> | 14. Strep throat |
| <input type="checkbox"/> | 7. African sleeping sickness | <input type="checkbox"/> | 15. Rocky Mountain spotted fever |
| <input type="checkbox"/> | 8. Measles | <input type="checkbox"/> | 16. Lyme disease |

Soft Skills

Do you have these?

1

#28: Positive Work Ethic & Attitude

If you have a great work ethic but a negative attitude, which one do you think will trump the other?

Belief in the moral value of work



#9: Eye Contact

Looking directly into the eyes of someone when you greet them or speak to them.

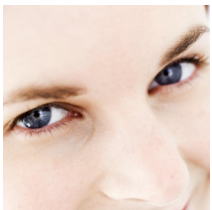

#29: Interpersonal Skills & #32: Personal Chemistry

Interpersonal Defined: of or pertaining to the relations between persons (www.dictionary.com)

Personal Chemistry: Do others want to be with you?

Grade 8 Bearcat Day 22 Careers

#34: Common Sense

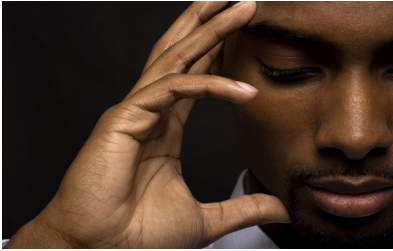

Good judgment – sound practical judgment based on “experience” rather than theory

Grade 8 Bearcat Day 22 Careers

53: Understanding What the World is About (What’s going on in the News?)



Know what’s going on
Even Yahoo! News is better than no news
Get connected, know what others are doing. Subscribe to Inc. or Fast Company.
Track a few stocks

#39: Good Personal Appearance

Visual aspect of a person – with regards to personal cleanness and neatness of clothing



#56: Willingness to take instruction and responsibility

Do you know someone who always blames others?
Do you know someone who thinks he/she already knows all the answers?



Grade 8 Bearcat Day 22 Careers

#57: Able to Relate to co-workers in a close environment



Connection with people or things
Water cooler talk
Business retreats
Team Activities

Grade 8 Bearcat Day 22 Careers

#60: Communication skills with public, fellow employees, supervisors, and customers

Are you a good listener?

How many of you have had a good boss/coach/teacher?

Telephone line...don't count on it working! Don't listen to hearsay when it comes to important information.

Networking within your business? Are you getting to know your fellow workers?



#58: Not expecting to be promoted within the first six months

"This is just a stepping stone for me"

Look at every opportunity to help you move to the next level. Don't expect to get a raise because others may have. They have more experience than you.



Memberships & Volunteering

Professional Organizations - Join!

Just like joining clubs at school, these connections can help you.

Volunteer Opportunities - Participate!

Board Member for non-profit agency
Junior Achievement



Soft Skills

One of the most difficult things to teach
And...the most common reason for not hiring, not promoting, & poor performance evaluation



Name _____

Soft Skills - Do you have these?

1. Making _____ (looking directly into the eyes of someone) is a soft skill
2. A _____ & _____ is the belief in the value of work
3. Interpersonal Skills pertains to the _____ between persons and Personal Chemistry determines if others want to _____
4. Common sense (good judgment) is based on _____ rather than theory
5. Good personal appearance deals with a person's _____ and _____ of clothing
6. Willingness to take _____ and _____ shows you don't blame others or think you already know all the answers
7. Water cooler talk and team activities is an example of _____ to your co-workers
8. _____ skills with the public, fellow employees, supervisors, and customers is important to employers.
9. Soft skills are difficult to teach and the most common reason for not _____, _____, and poor _____.
10. Use your device, get help from a sibling or parent to think of some more soft skills that employers desire. Write a list of 10 - 15 skills below that are not already mentioned in the presentation.